

Alfa Laval Safety Valve

Safety valves

Introduction

The Alfa Laval Safety Valve is a versatile hygienic spring-loaded relief valve that prevents pressure buildup in process tanks, vessels and equipment due to blocked discharge, thermal expansion, chemical reactions, or a combination of these events.

Application

This safety valve is ideal for use in the dairy, food, beverage, biotechnology, pharmaceutical and many other industries.

Benefits

- Safe, reliable operation
- Hygienic design
- Prevents unsanitary leakage and overflow
- Safeguards both personnel and equipment against accidents due to overpressure
- Optional manual or automated overwrite for valve cleaning

Standard design

The Alfa Laval Safety Valve comes in sizes from DN25 to DN100 with a spring-loaded set pressure range from 0.2 to 12 bar. The valve can be operated either pneumatically or manually. It is delivered with PED certificate and complies with PED 2014/68/EU and EN 4126-1, fluid group II (non-hazardous fluids). It is available for pressure regulation of both liquids and gases. Please note that manual pressure regulation of gases has a reduced pressure range.

Working principle

The Alfa Laval Safety Valve prevents inadmissible overpressures of fluids in tanks, containers and plant sections. It is factory-configured with the specified set pressure that is greater than the operating pressure. If the operating pressure rises above the set pressure, the valve opens against the spring force to relieve pressure.

The valve should be installed in a vertical position for optimal performance. If mounted in a horizontal position, the set pressure will be somewhat lower than specified due to the lack of weight from the piston. The highest effect is obtained using DN80 and DN100.



TECHNICAL DATA

Temperature	
Temperature range:	+5°C to +95 °C
Max. sterilisation temperature, dry steam:	140 °C (Max 30 min)

*DN25 for gas applications is only available for set pressure up to 1.5 bar

PHYSICAL DATA

Materials	
Product wetted parts:	1.4404 (316L)
Other steel parts:	1.4301 (304)
Seals:	EPDM
External finish:	Ra 1.5-2.5 µm
Internal finish:	Ra 0.8 µm
Connections:	Liner/nut - male DIN 11851

Option:

Inductive sensor for feedback is available for standard and pneumatic lifting - see instruction manual for detail.

Dimensions (mm)

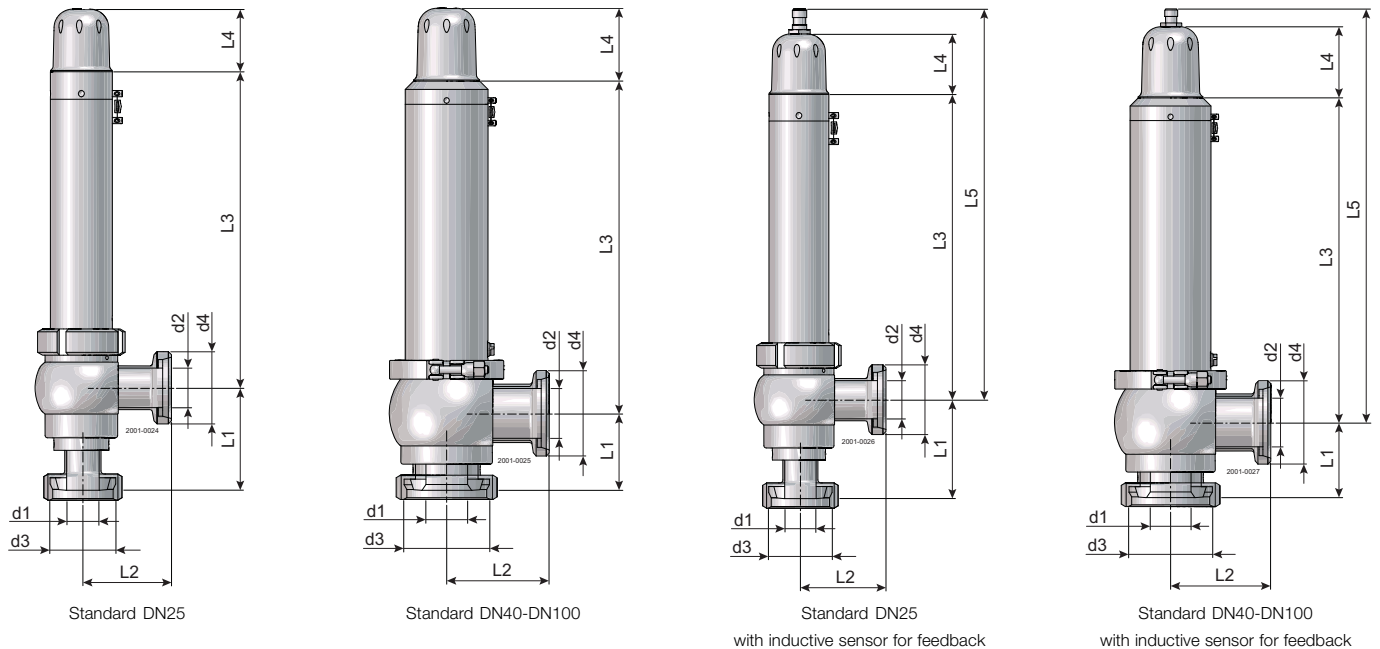

Standard									
Size	d1	d2	d3	d4	L1	L2	L3	L4	Kg
DN25	26	32	Rd52x1/6	Rd58x1/6	82	72	253	50	6.8
DN40	32	38	Rd65x1/6	Rd65x1/6	68	82	255	66	9.1
DN50	38	50	Rd78x1/6	Rd78x1/6	70	93	301	66	1.3
DN65	50	66	Rd95x1/6	Rd95x1/6	85	105	402	66	15.0
DN80	66	81	Rd110x1/4	Rd110x1/4	100	115	407.5	66	22.0
DN100	81	100	Rd130x1/4	Rd130x1/4	130	130	418	66	28.2

Standard with inductive sensor for feedback										
Size	d1	d2	d3	d4	L1	L2	L3	L4	L5	Kg
DN25	26	32	Rd52x1/6	Rd58x1/6	82	72	253	50	324	6.8
DN40	32	38	Rd65x1/6	Rd65x1/6	68	82	255	66	338	9.1
DN50	38	50	Rd78x1/6	Rd78x1/6	70	93	301	66	384	1.3
DN65	50	66	Rd95x1/6	Rd95x1/6	85	105	402	66	484	15.0
DN80	66	81	Rd110x1/4	Rd110x1/4	100	115	407.5	66	489	22.0
DN100	81	100	Rd130x1/4	Rd130x1/4	130	130	418	66	501	28.2

Dimensions (mm)

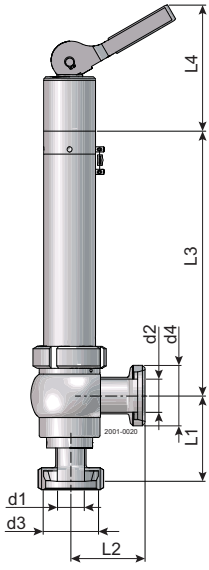

Manual lifting DN25

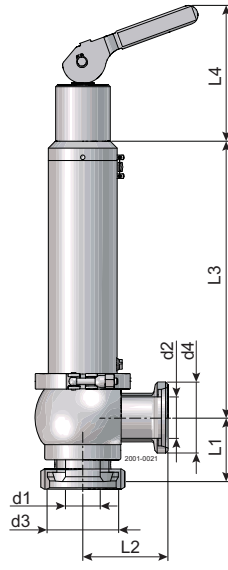

Manual lifting DN40-DN100

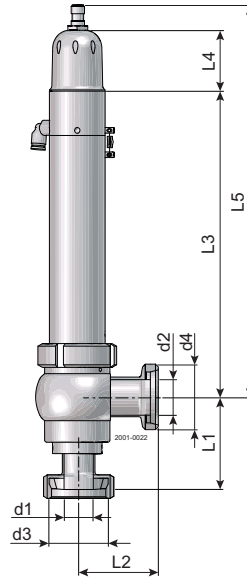

Pneumatic lifting DN25 with inductive sensor for feedback

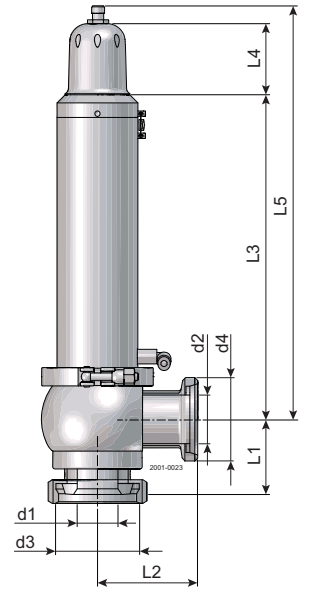

Pneumatic lifting DN40-DN100 with inductive sensor for feedback

Manual lifting

Size	d1	d2	d3	d4	L1	L2	L3	L4	Kg
DN25	26	32	Rd52x1/6	Rd58x1/6	82	72	253	141-182	7.5
DN40	32	38	Rd65x1/6	Rd65x1/6	68	82	255	152-232	10.3
DN50	38	50	Rd78x1/6	Rd78x1/6	70	93	301	154-234	15.5
DN65	50	66	Rd95x1/6	Rd95x1/6	85	105	402	153-233	16.2
DN80	66	81	Rd110x1/4	Rd110x1/4	100	115	407.5	152.5-232.5	23.2
DN100	81	100	Rd130x1/4	Rd130x1/4	130	130	418	152-232	29.6

Pneumatic lifting with inductive sensor for feedback

Size	d1	d2	d3	d4	L1	L2	L3	L4	L5	Kg
DN25	26	32	Rd52x1/6	Rd58x1/6	82	72	253	50	324	6.8
DN40	32	38	Rd65x1/6	Rd65x1/6	68	82	255	66	338	9.1
DN50	38	50	Rd78x1/6	Rd78x1/6	70	93	301	66	384	1.3
DN65	50	66	Rd95x1/6	Rd95x1/6	85	105	402	66	484	15
DN80	66	81	Rd110x1/4	Rd110x1/4	100	115	407.5	66	489	22
DN100	81	100	Rd130x1/4	Rd130x1/4	130	130	418	66	501	28.2

Opening and closing characteristics for incompressible fluids (Liquid)

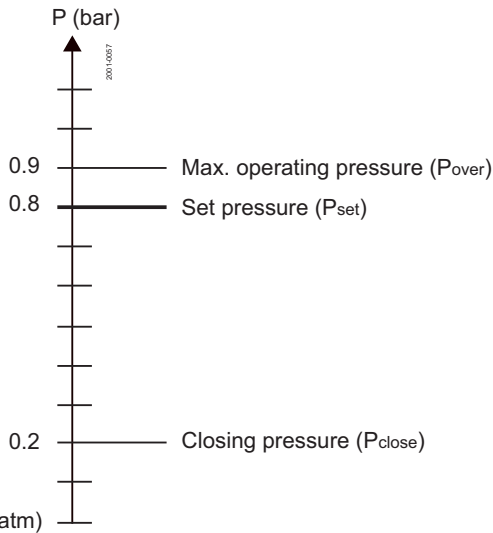

(Example: Set pressure = 0.8 bar)

Max. operating pressure (P_{over}):

10 % of set pressure or 0.1 bar, whichever is the greater.

Closing pressure (P_{close}):

Maximum 20% or 0.6 bar below set pressure, whichever is the greater

Opening and closing characteristics for compressible fluids (Gas)

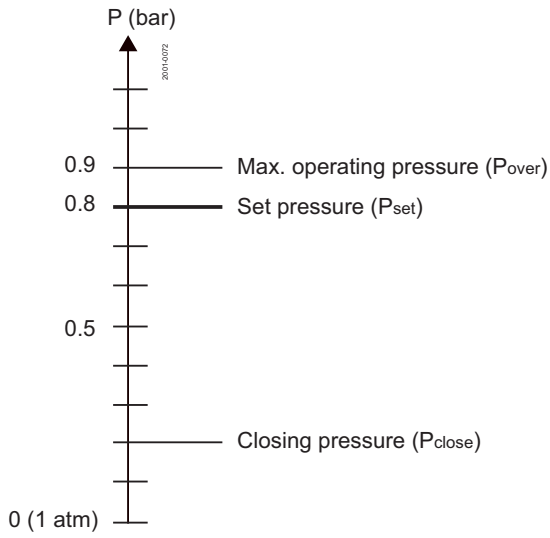

(Example: Set pressure = 0.8 bar)

Max. operating pressure (P_{over}):

10 % of set pressure or 0.1 bar, whichever is the greater.

Closing pressure (P_{close}):

Maximum 15% or 0.3 bar below set pressure, whichever is the greater

Blow-off performance chart

DN25 set pressure: 0.2 - 12.0 bar for liquids (water 20 °C)

Flow rate [m³/h]

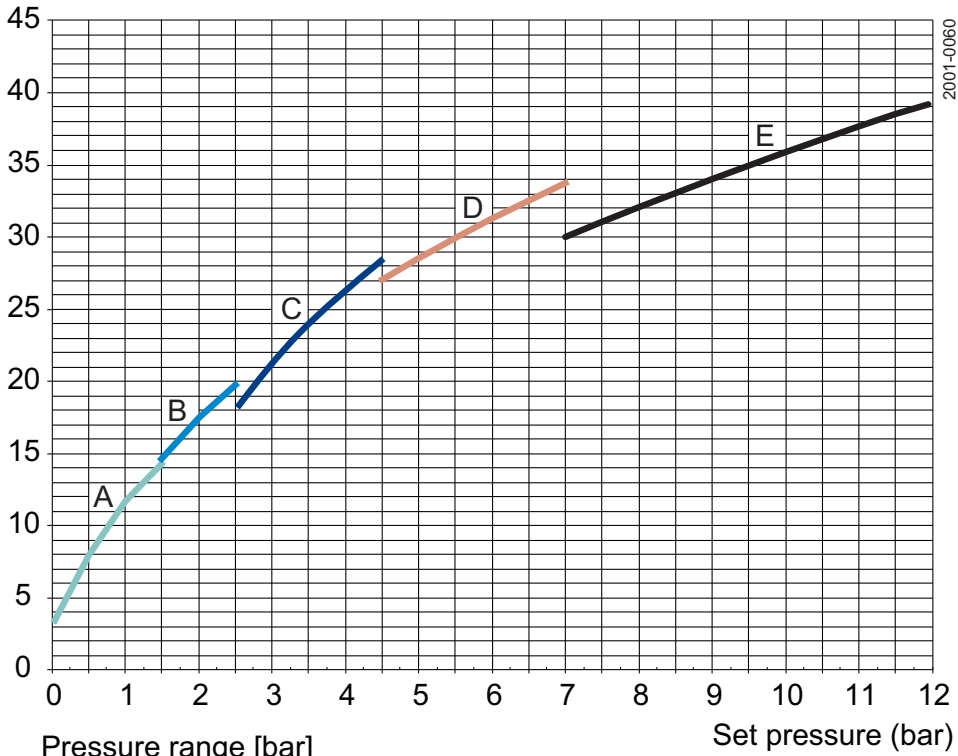

2001-0060

Pressure range [bar]

A = 0.5 - 1.5

B = 1.6 - 2.5

C = 2.6 - 4.5

D = 4.6 - 7.0

E = 7.1 - 12.0

Set pressure (bar)

DN 25 set pressure: 0.2 - 12 bar for gases (air 20 °C)

Flow rate [m³/h]

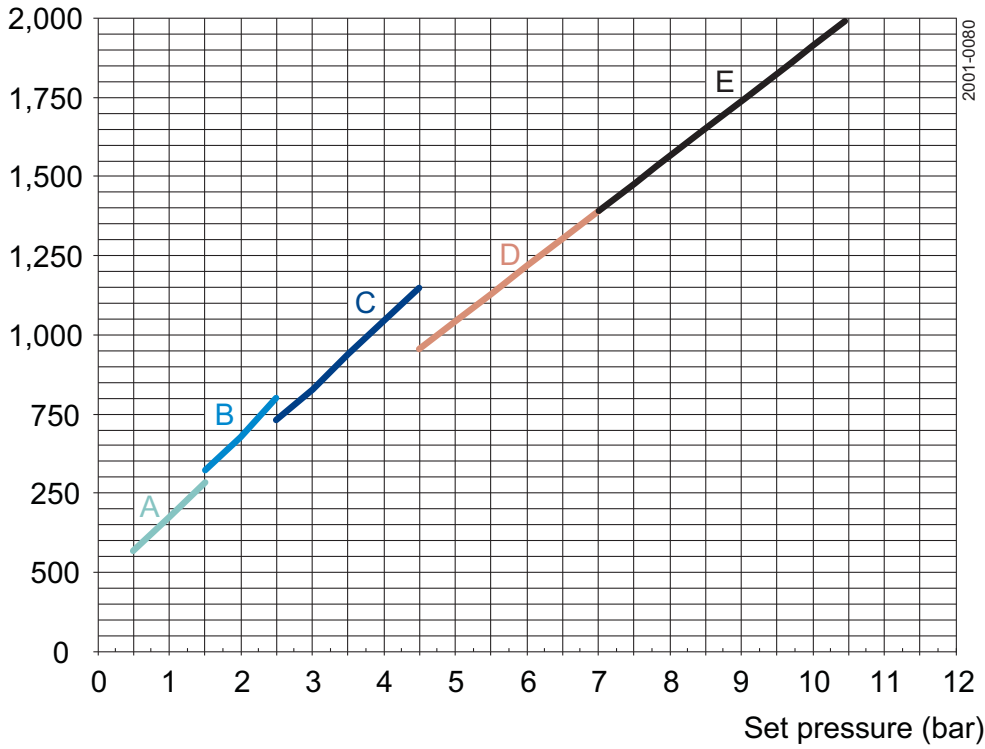

Pressure range [bar]

A = 0.2 - 1.5

D = 4.6 - 7

B = 1.6 - 2.5

E = 7.1 - 12

C = 2.6 - 4.5

Blow-off performance chart

DN 40 set pressure: 0.2 - 12.0 bar for liquids (water 20 °C)

Flow rate [m³/h]

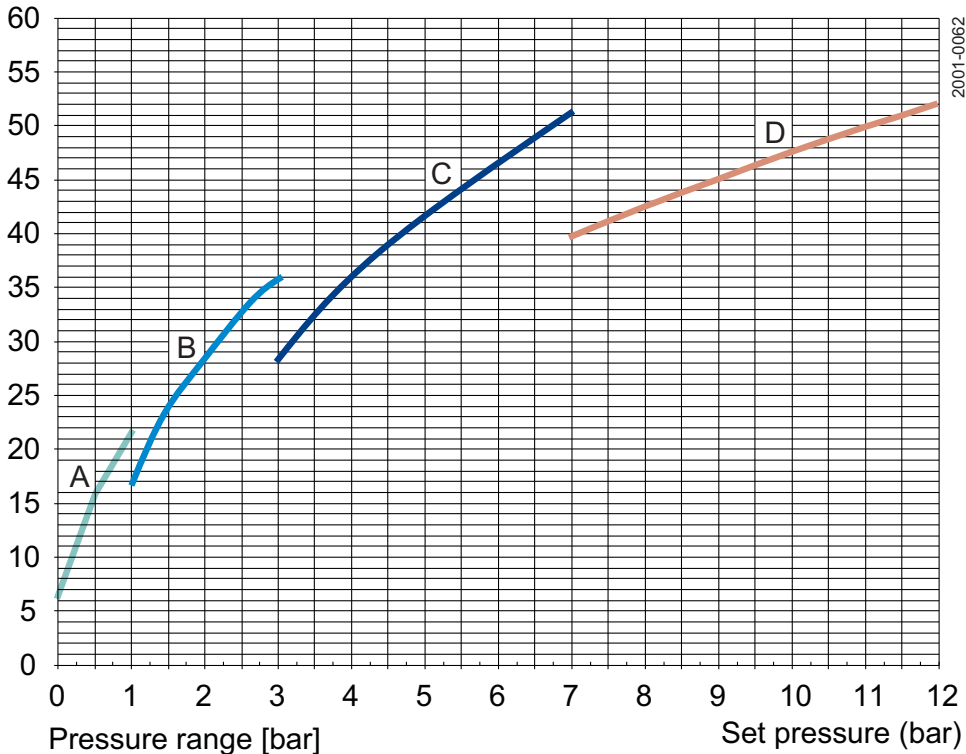

2001-0062

Pressure range [bar]

A = 0.2 - 1.0

B = 1.1 - 3.0

C = 3.1 - 7.0

D = 7.1 - 12.0

DN 40 set pressure: 0.2 - 12.0 bar for gases (air 20 °C)

Flow rate [m³/h]

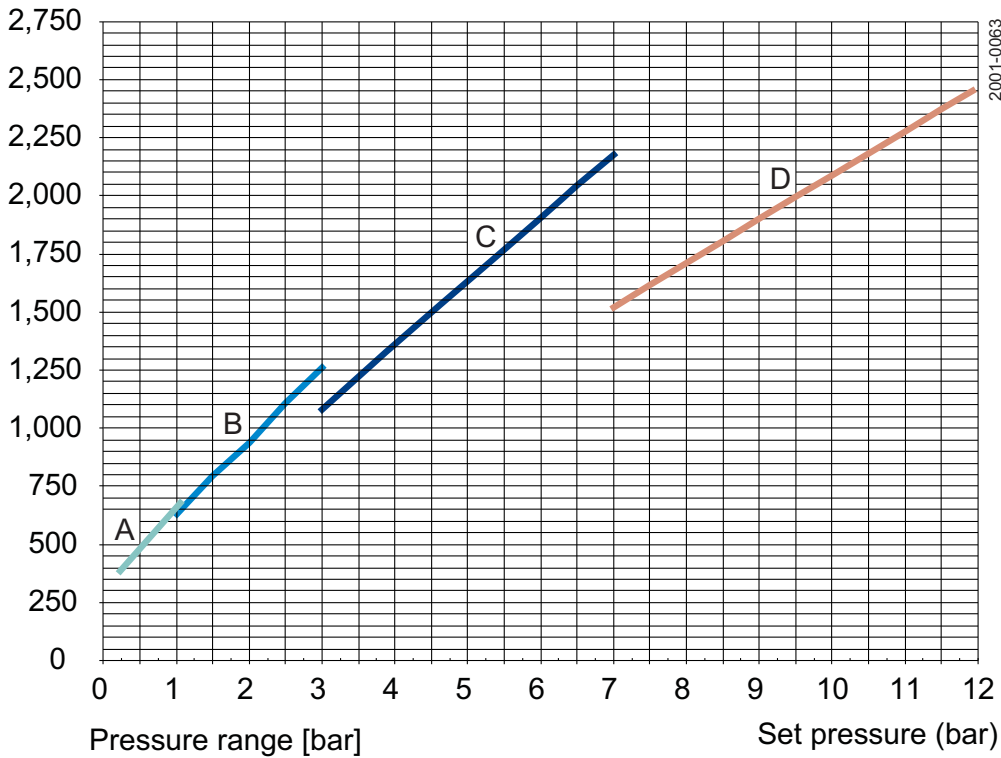

Pressure range [bar]

A = 0.2 - 1.0

B = 1.1 - 3.0

C = 3.1 - 7.0

D = 7.1 - 12.0

Set pressure (bar)

2001-0063

Blow-off performance chart

DN 50 set pressure: 0.3 - 12.0 bar for liquids (water 20 °C)

Flow rate [m³/h]

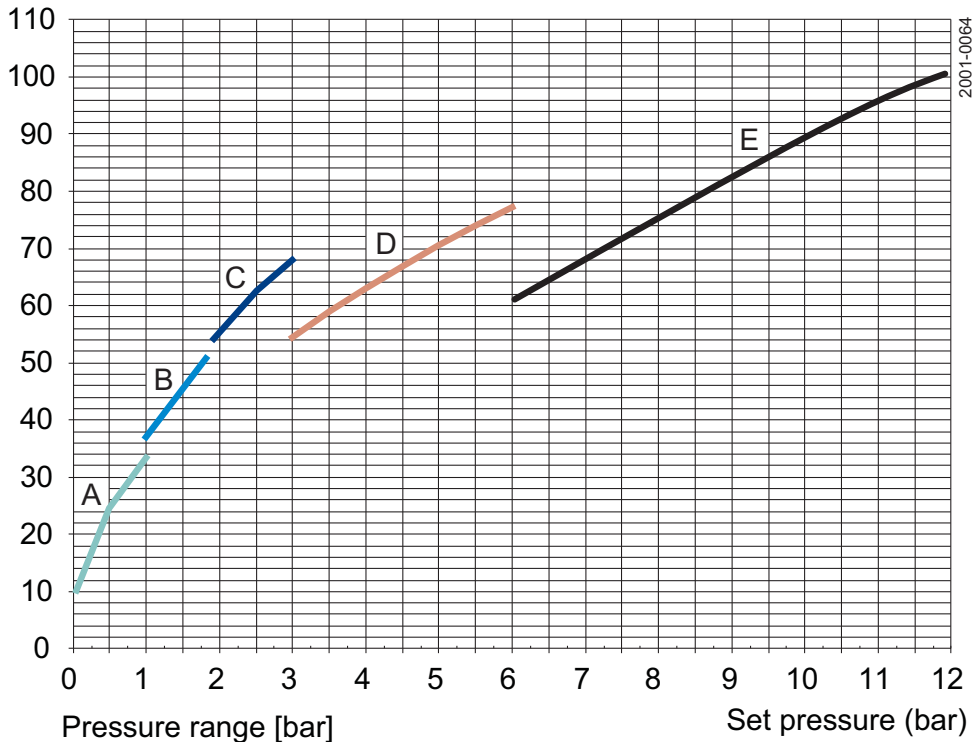

2001-0064

Pressure range [bar]

A = 0.3 - 0.9

B = 1.0 - 1.7

C = 1.8 - 2.9

D = 3.0 - 6.0

E = 6.1 - 12.0

Set pressure (bar)

DN50 set pressure: 0.3 - 12.0 bar for gases (air 20 °C)

Flow rate [m³/h]

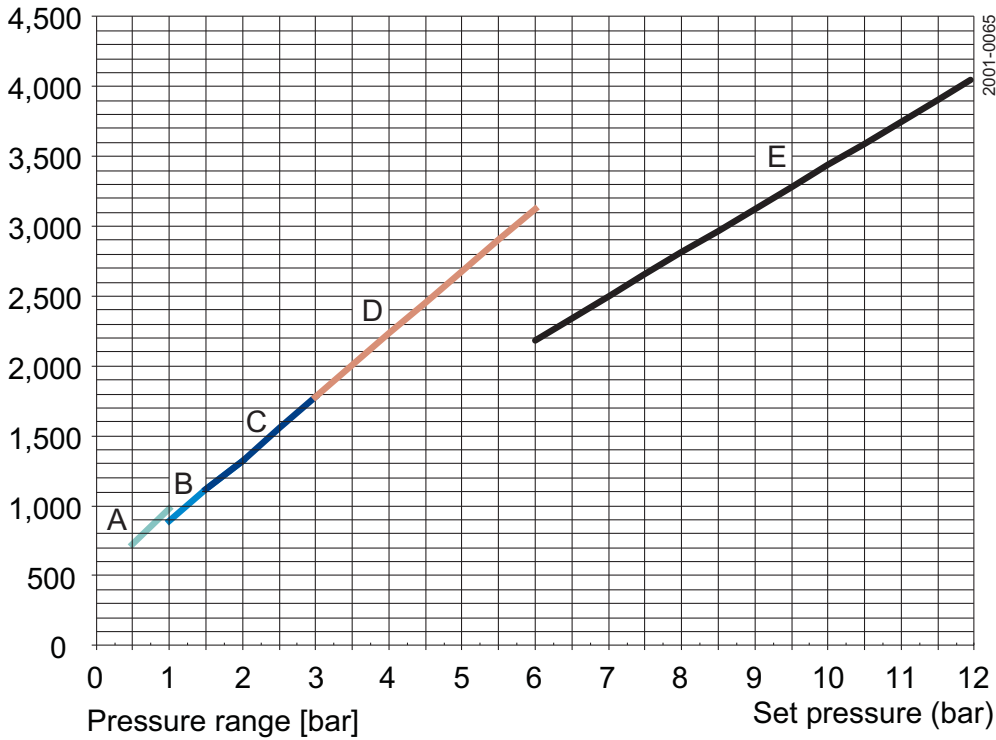

Pressure range [bar]

A = 0.3 - 0.9

B = 1.0 - 1.7

C = 1.8 - 2.9

D = 3.0 - 6.0

E = 6.1 - 12.0

DN65 set pressure: 0.4 - 9.0 bar for liquids (water 20 °C)

Flow rate [m³/h]

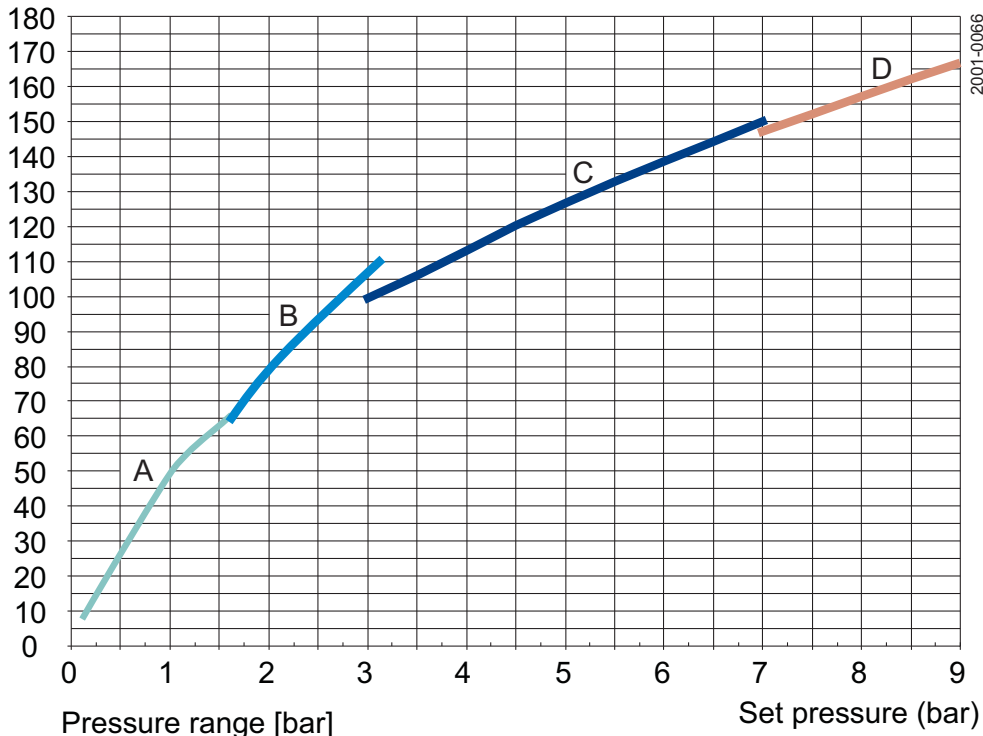

Pressure range [bar]

A = 0.4 - 1.5

C = 3.1 - 7.0

B = 1.5 - 3.0

D = 7.1 - 9.0

DN65 set pressure: 0.4 - 9.0 bar for gases (air 20 °C)

Flow rate [m³/h]

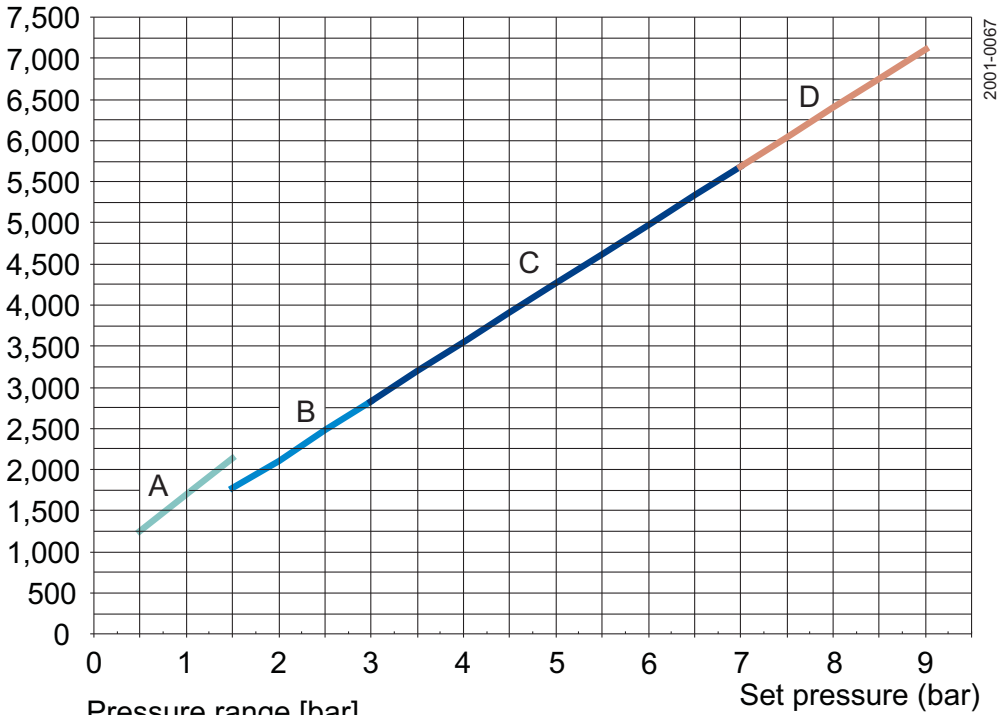

Pressure range [bar]

A = 0.4 - 1.5

C = 3.1 - 7.0

B = 1.5 - 3.0

D = 7.1 - 9.0

DN80 set pressure: 0.3 - 8.0 bar for liquids (water 20 °C)

Flow rate [m³/h]

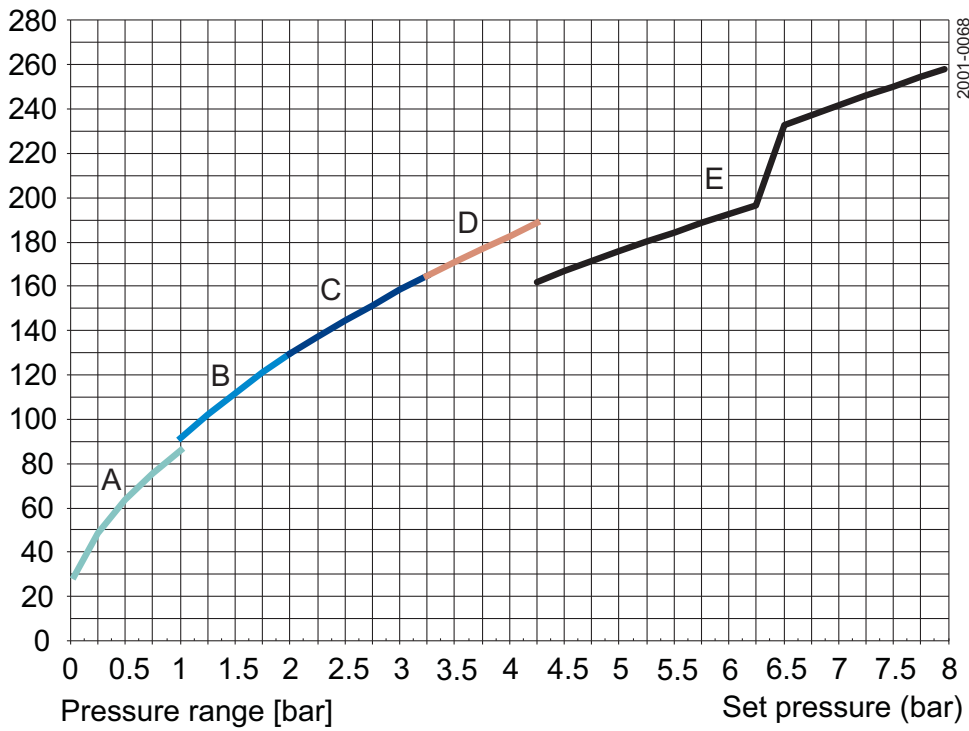

2001-0068

Pressure range [bar]

A = 0.3 - 0.9

B = 1.0 - 1.9

C = 2.0 - 3.3

D = 3.4 - 4.3

E = 4.4 - 8.0

Set pressure (bar)

DN80 set pressure: 0.3 - 8.0 bar for gases (air 20 °C)

Flow rate [m³/h]

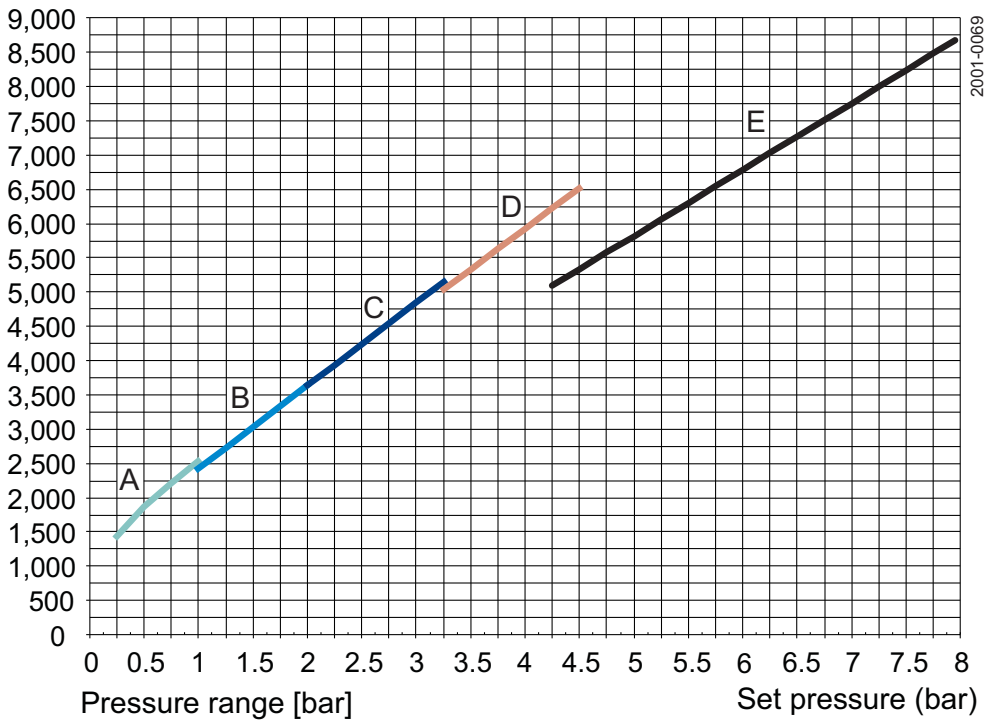

Pressure range [bar]

Set pressure (bar)

A = 0.3 - 0.9

D = 3.4 - 4.3

B = 1.0 - 1.9

E = 4.4 - 8.0

C = 2.0 - 3.3

DN100 set pressure: 0.3 - 3.2 bar for liquids (water 20 °C)
 Flow rate [m³/h]

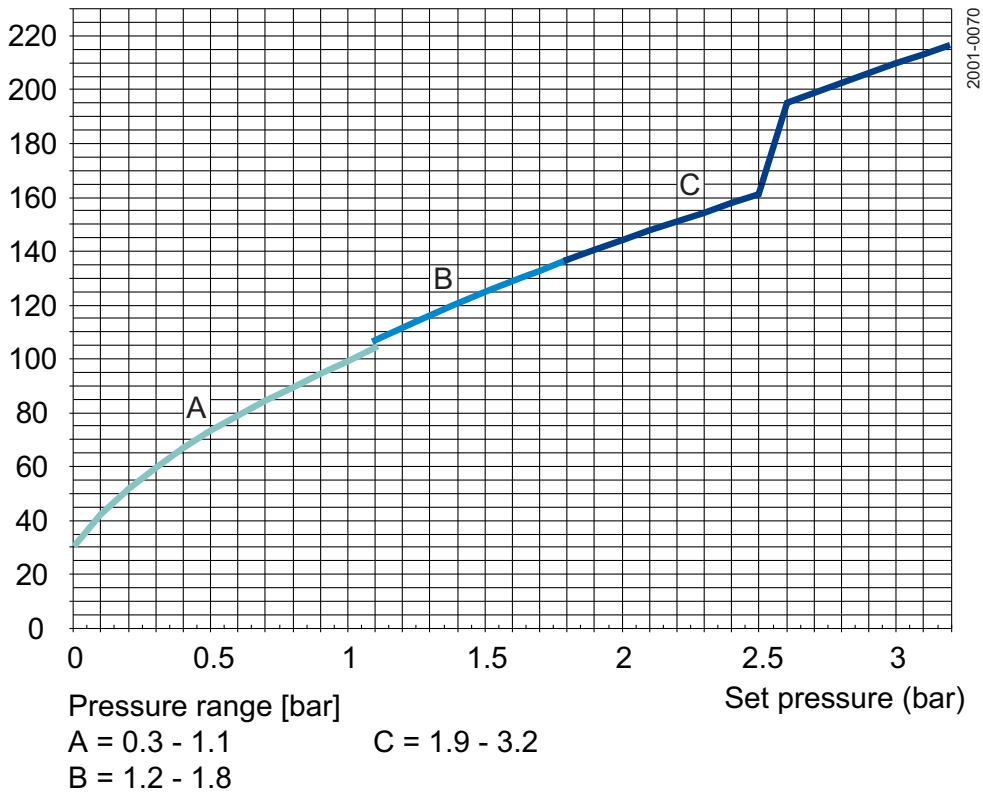

DN100 set pressure: 0.3 - 3.2 bar for gases (air 20 °C)
 Flow rate [m³/h]

